

2804-L4 -
Portaimpronta forati in acciaio inox - PERMA-LOCK /
Perforated stainless steel impression trays - PERMA-LOCK

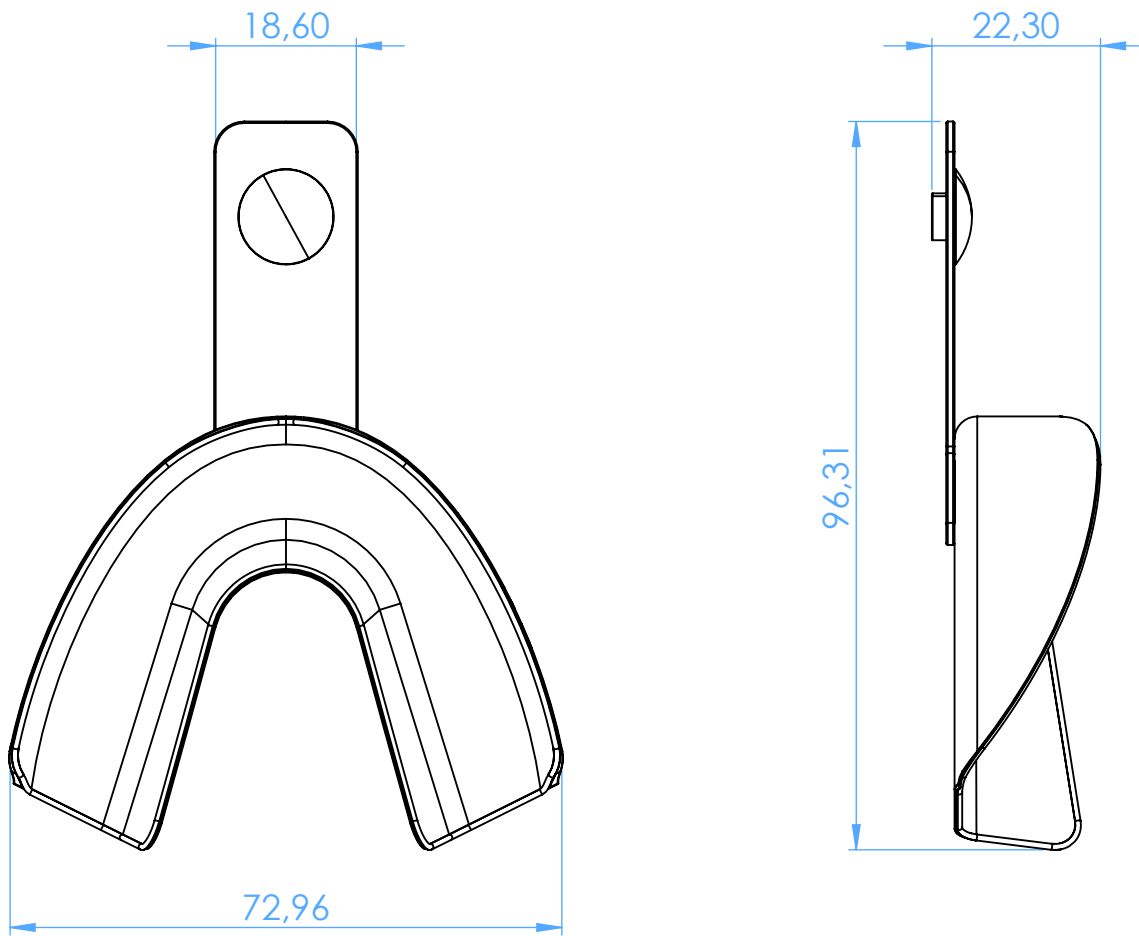

SCALE 1:1